

# LINEAR CYLINDERS

## SERIES LI

### ▶ PRODUCT ADVANTAGES

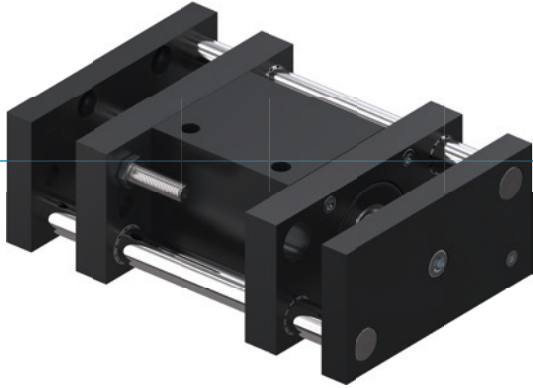

#### ▶ Large locating flange

The large mounting surface simplifies your design and allows secure attachment of follow-on tools









#### ▶ Dampened end position

By using PowerStop shock absorbers, you can gently move up to the end positions, increasing the process reliability and durability of your application

#### ▶ Failure-free continuous operation

Our uncompromising “Made in Germany” quality guarantees up to 10 million maintenance-free cycles

### ▶ SERIES CHARACTERISTICS

Installation size	Version		
LIXX		D	S
 2 way guiding			●
 3 way guiding		●	
 Continuous piston rod		●	
 10 million maintenance-free cycles (max.)	●	●	●
 Inductive sensor	●	●	●
 Elastomer end position damping	●	●	●
 Powerstop end position damping	●	●	●
 IP 54	●	●	●



## ► BENEFITS IN DETAIL

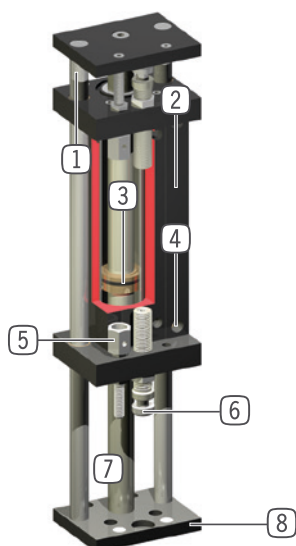

- ① **Guide rod**
  - hardened, polished steel shaft
- ② **Mounting block**
  - mounting for inductive proximity switch
- ③ **Drive**
  - double-acting pneumatic cylinder
- ④ **Energy supply**
  - reducing exhaust air is recommended
- ⑤ **End stop confirmation screw**
  - direct flange position sensing
  - included in scope of delivery
- ⑥ **End position damping**
  - with elastomer absorber or patented hydraulic shock absorber
- ⑦ **Piston rod**
  - polished, hard chrome plated steel
  - continuous in design D
- ⑧ **Intake flange**
  - for connection to application-specific adapter plate (to be supplied by the customer)

## ► TECHNICAL DATA

Installation size	Stroke [mm]	Pressure force max. [N]	Retraction force [N]	Weight [kg]	IP class
L116	20 - 50	80 - 100	80	0,05 - 0,1	IP54
L130	15 - 90	200 - 270	200	0,05 - 0,1	IP54
L140	40 - 300	270 - 450	270	0,05 - 0,3	IP54
L150	50 - 300	950	950	0,03 - 0,2	IP54

## ► FURTHER INFORMATION IS AVAILABLE ONLINE



All information just a click away at: [www.zimmer-group.com](http://www.zimmer-group.com). Find data, illustrations, 3D models and operating instructions for your installation size using the order number for your desired product. Quick, clear and always up-to-date.

# LINEAR CYLINDERS

## LI50-50S / LI50-90S

### ▶ PRODUCT SPECIFICATIONS



#### ▶ Forces and moments

Max allowable static forces and moments.

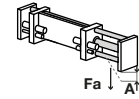

### ▶ RECOMMENDED ACCESSORIES



#### ENERGY SUPPLY



**DRV1-8X6**  
Flow Control Valves - with Swivel joint



#### SENSORS



**NJ12-E2S**  
Inductive proximity switch - Connector M8



#### CONNECTIONS / OTHER



**AP50-S**  
Adapter plate



#### CONNECTIONS / OTHER



**AI-M8X1-53**  
Stop Stroke Adjustment Screws



**PHE20X15NSDE-A**  
Industrial shock absorbers PowerStop



**KAG500**  
Plug-in connector Straight Cable 5m - Socket M8 (female)



**KAW500**  
Plug-in connector Angled Cable 5m - Socket M8 (female)



**ZE30H7X4**  
Centering Disc

Order no.	► Technical data	
	LI50-50S	LI50-90S
Stroke [mm]	50	90
Pressure force max. [N]	950	950
Retraction force [N]	950	950
Travel time without external load [s]	0.13	0.24
Nominal operating pressure [bar]	6	6
Operating temperature min. [°C]	5	5
Operating temperature max. [°C]	+80	+80
Air volume per cycle [cm³]	166	300
Weight [kg]	2.9	3.6
Load Fa max. [N]	300	200
Max. deflection A [mm]	0.03	0.05
Radial load Mr max. [Ncm]	1500	1100
Max. rotation D at 100 mm [mm]	0.08	0.08

- ① Fixing linear cylinder
- ② Energy supply
- ③ Fixing application
- ⑤ Stop screw for stroke limitation
- ⑧ Fixing for adapter plate
- ⑫ Intake for shock absorbers
- ⑬ Intake proximity switch
- Ⓐ Air connection (retract)
- Ⓑ Air connection (extend)

