

# 线性气缸

## LI 系列

### ▶ 产品优点

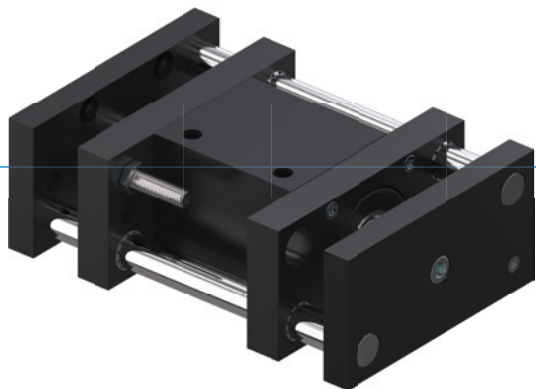

#### ▶ 大定位法兰

大连接面简化了您的设计并且可牢固连接后续工具









#### ▶ 终端位置缓冲

摆到最终位置时用液压缓冲器平缓缓冲, 这样使您的生产更稳定, 应用使用寿命更长

#### ▶ 无间断的持续工作

“德国制造”象征着我们精益求精的质量要求, 保证免维护运行一千万次循环

### ▶ 产品特点

尺寸型号	版本		
	LIXX	D	S
 2路导向			●
 3路导向		●	
 通用活塞杆		●	
 (最多)1千万次循环免维护	●	●	●
 接近传感器	●	●	●
 弹性体终端位置减振装置	●	●	●
 Powerstop 终端位置减振装置	●	●	●
 IP54	●	●	●



## 优势细节

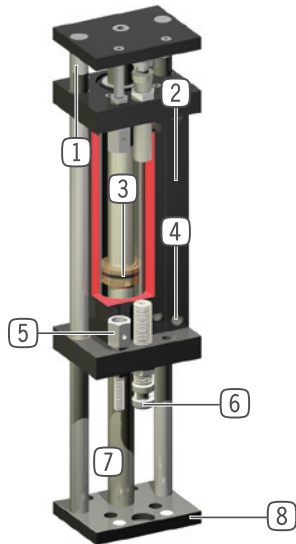

- ① **导轨**
  - 抛光的加固钢杆
- ② **安装块**
  - 安装接近开关
- ③ **驱动**
  - 双作用气缸
- ④ **能源供应**
  - 减少排气时间
- ⑤ **终端位置确认螺丝**
  - 直接检测法兰位置
  - 随厂包括
- ⑥ **最终位置缓冲**
  - 用塑料缓冲器或专利技术的油压缓冲器
- ⑦ **活塞杆**
  - 抛光镀硬铬钢
  - D型号里面是一体的
- ⑧ **工具端连接法兰**
  - 用于特定应用的连接板(由客户提供)

## 技术数据

尺寸型号	行程 [mm]	压力 [N]	最大收缩力 [N]	重量 [kg]	IP 等级
LI16	20 - 50	80 - 100	80	0,05 - 0,1	IP54
LI30	15 - 90	200 - 270	200	0,05 - 0,1	IP54
LI40	40 - 300	270 - 450	270	0,05 - 0,3	IP54
LI50	50 - 300	950	950	0,03 - 0,2	IP54

## 更多详情请上网查询



所有信息查询请点击:[www.zimmer-group.com](http://www.zimmer-group.com)。产品参数、绘图、3D模型和操作说明均可根据产品型号查询。清晰且实时更新。

# 线性气缸

## LI50-250S / LI50-300S

### ▶ 产品规格



### ▶ 力和力矩

静态负荷下的最大动力和扭矩消耗。

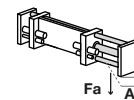

### ▶ 配件建议



#### 能源供应



**DRV1-8X6**  
流量控制阀 - 转动式



#### 传感器



**NJ12-E2S**  
接近开关 - M8接头



#### 接口 / 其他



**AP50-S**  
适配板



#### 接口 / 其他



**AI-M8X1-53**  
停止位置调节螺丝



**PHE20X15NSDE-A**  
工业缓冲器 PowerStop



**KAG500**  
插入式直连接头电缆 5 m - M8插头(母头)



**KAW500**  
插入式弯角连接头电缆 5 m - M8插头(母头)



**ZE30H7X4**  
中心定位环

