

TOOL CHANGERS

SERIES FWR

▶ PRODUCT ADVANTAGES



▶ Automated tool change without external activation

In interaction with the storage station, the changer is actuated mechanically during retraction. As a result, no additional power supply is required for the change operation.

▶ Manual tool change

The sizes FWR40 and FWR50 can be opened with just one hand. If this is not desired, you can lock the actuation manually.

▶ Optional media transmission

Adapt the tool changer to your application. With the energy elements of the WER1000 and WER2000 series, you can transmit a variety of media with standard connections!

▶ THE BEST PRODUCT FOR YOUR APPLICATION



▶ Our products welcome the challenge!

Extreme conditions, all over the world—our tried and tested components and systems give you endless possibilities.

Find the best product for your specific use:

www.zimmer-group.com

► BENEFITS IN DETAIL

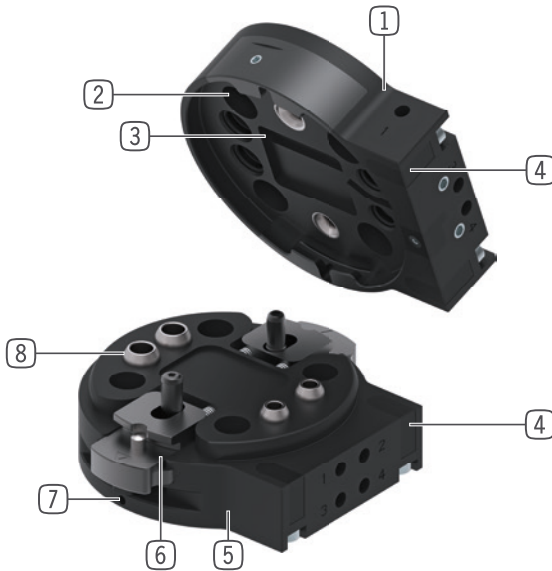

- ① **Fix part**
- For robot side assembly
- ② **Connecting flange**
- partial mounting circle in accordance with EN ISO 9409-1
- ③ **Loose part presence sensing**
- via inductive proximity switch
- ④ **Mounting for energy element**
- Direct connection, without adapter plates
- ⑤ **Loose part**
- for tool side assembly
- ⑥ **Locking**
- Manual actuation
- Automatic actuation via a storage station
- ⑦ **Lock for manual actuation (optional)**
- Secure against inadvertent loosening
- ⑧ **Integrated air feed-through**
- Air / vacuum transfer
- hoseless control possible

► TECHNICAL DATA

Installation size	Connecting flange according EN ISO 9409-1	Handling weight max.*	Tool weight max.**	Pneumatic energy transfer
		[kg]	[kg]	[Quantity]
FWR40	TK 40	13	5	4
FWR50	TK 50	16	7	4
FWR63	TK 63	20	10	4
FWR80	TK 80	29	12	4

*The **handling weight** is the maximum weight that may be on the tool changer.

Handling weight = end effector + workpiece

The **tool weight is the maximum weight of the end effector that may be in the storage station (without workpiece).

Tool weight = end effector + loose part

► FURTHER INFORMATION IS AVAILABLE ONLINE



All information just a click away at: www.zimmer-group.com. Find data, illustrations, 3D models and operating instructions for your installation size using the order number for your desired product. Quick, clear and always up-to-date.

TOOL CHANGERS

INSTALLATION SIZE FWR63

▶ PRODUCT SPECIFICATIONS



▶ Variable installation position

Shows the maximum handling weight depending on acceleration and lever arm. Does not replace the technical design.

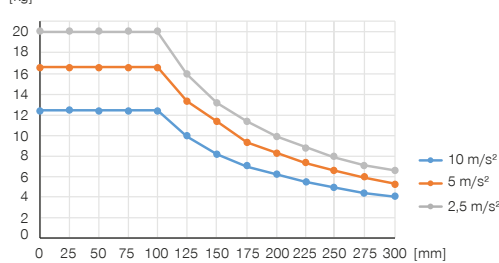

▶ Forces and moments

Shows static forces and moments which may impact on the tool changer.

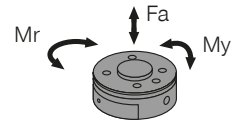

Mr [Nm]	100
My [Nm]	100
Fa [N]	1900

▶ INCLUDED IN DELIVERY

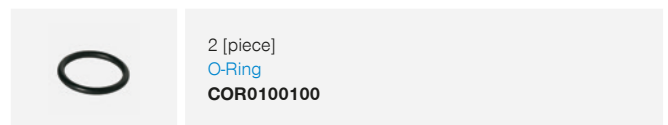
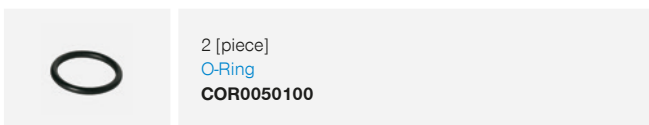
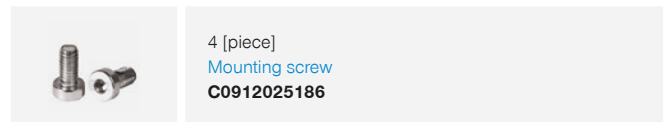
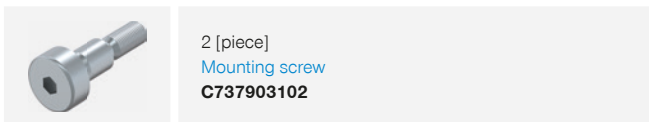

▶ RECOMMENDED ACCESSORIES

ENERGY SUPPLY



CONNECTIONS / OTHER

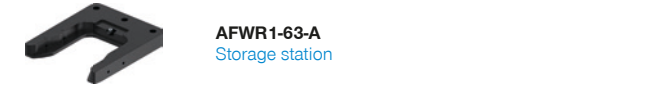
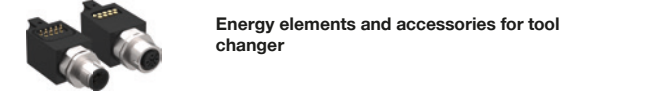

SENSORS



▶ RECOMMENDED ACCESSORY STORAGE STATION

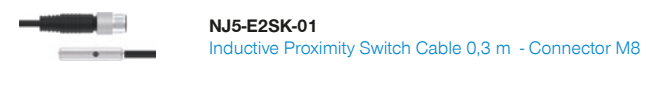

Order no.	► Technical data	
	FWR63F-00-A	FWR63L-00-A
Connecting flange according EN ISO 9409-1	TK 63	TK 63
Handling weight max. [kg]	20	20
Tool weight max. [kg]	10	10
Pneumatic energy transfer [Quantity]	4	4
Flow per connector M5 [l/min]	170	170
Flow per connector G1/8" [l/min]	650	650
Electrical energy transfer	optional	optional
Locking stroke [mm]	1	
Repetition accuracy in Z [mm]	0.02	
Repetition accuracy in X, Y [mm]	0.03	
Joining force [N]	0	0
Release force [N]	0	0
Offset at coupling max. in X,Y [mm]	2.2	2.2
Offset at coupling max. in X,Y [°]	1.5	1.5
Tightening force [N]*	100	
Tightening torque [Nm]*	5	
Operating pressure for energy transmission [bar]	-0.6 ... 6	-0.6 ... 6
Operating temperature [°C]	5 ... +80	5 ... +80
Moment of inertia [kgcm ²]	5.98	7.25
Protection to IEC 60529	IP44**	IP44**
Weight [kg]	0.43	0.57

*Note the mating force of the energy elements!

**only in coupled state

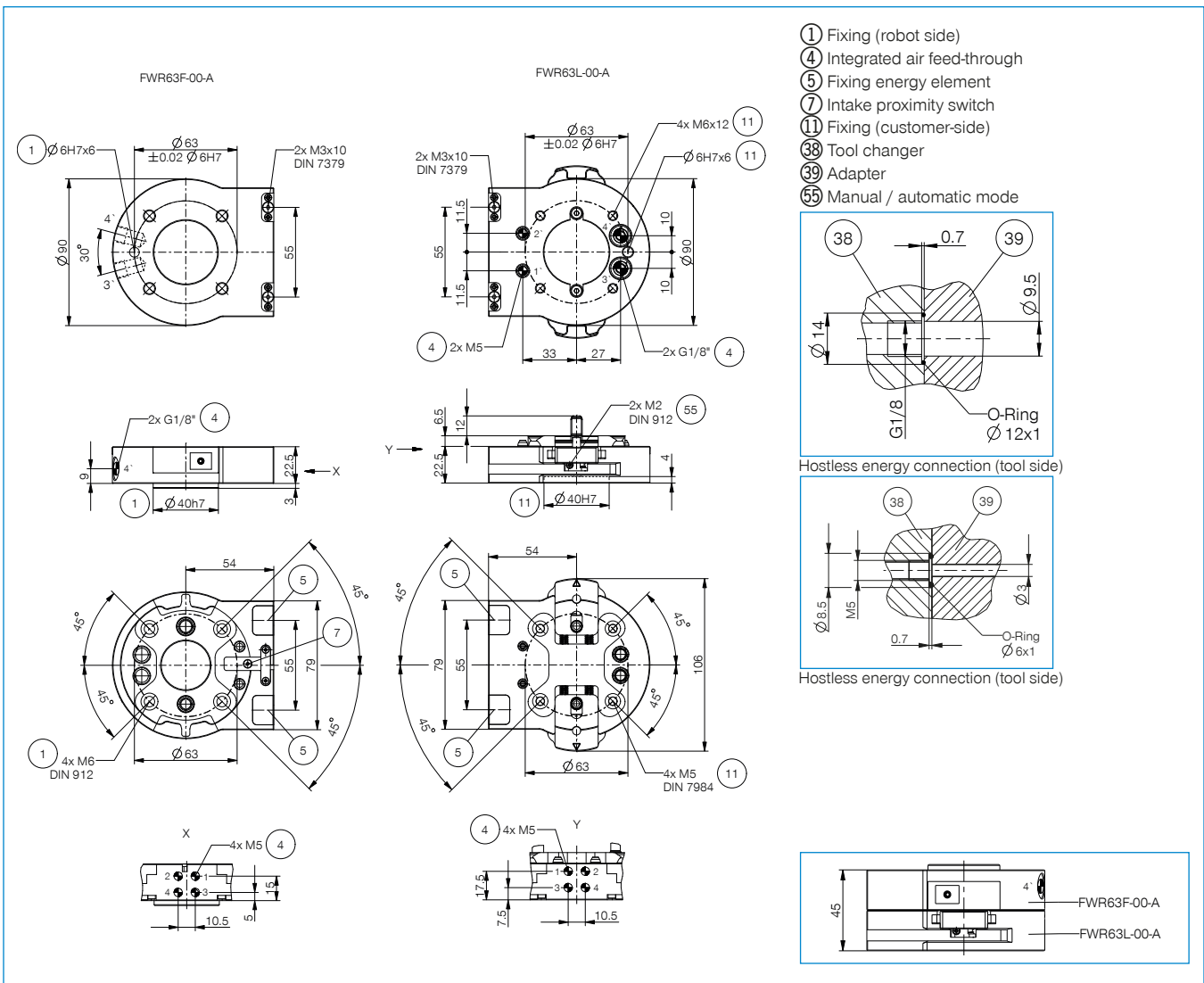

ENERGY ELEMENTS FOR TOOL CHANGER

SIZES FWR63 / FWR80

▶ CONNECTION DIAGRAM

